

AVTECH ELECTROSYSTEMS LTD.

NANOSECOND WAVEFORM ELECTRONICS  
SINCE 1975

□ P.O. BOX 265  
OGDENSBURG, NY  
U.S.A. 13669-0265

TEL: 888-670-8729 (USA & Canada) or +1-613-226-5772 (Intl)  
FAX: 800-561-1970 (USA & Canada) or +1-613-226-2802 (Intl)

info@avtechpulse.com - <http://www.avtechpulse.com/>

☒ BOX 5120, LCD MERIVALE  
OTTAWA, ONTARIO  
CANADA K2C 3H4

## INSTRUCTIONS

AVNN SERIES

25 MHz TO 250 MHz

HIGH SPEED PULSE GENERATOR

WITH 100 ps RISE & FALL TIMES

SERIAL NUMBER: \_\_\_\_\_

### WARRANTY

Avtech Electrosystems Ltd. warrants products of its manufacture to be free from defects in material and workmanship under conditions of normal use. If, within one year after delivery to the original owner, and after prepaid return by the original owner, this Avtech product is found to be defective, Avtech shall at its option repair or replace said defective item. This warranty does not apply to units which have been disassembled, modified or subjected to conditions exceeding the applicable specifications or ratings. This warranty is the extent of the obligation assumed by Avtech with respect to this product and no other warranty or guarantee is either expressed or implied.

### TECHNICAL SUPPORT

Phone: 888-670-8729 (USA & Canada) or +1-613-226-5772 (Intl)

Fax: 800-561-1970 (USA & Canada) or +1-613-226-2802 (Intl)

E-mail: [info@avtechpulse.com](mailto:info@avtechpulse.com)

World Wide Web: <http://www.avtechpulse.com>

## TABLE OF CONTENTS

<b>WARRANTY</b> .....	<b>2</b>
<b>TECHNICAL SUPPORT</b> .....	<b>2</b>
<b>TABLE OF CONTENTS</b> .....	<b>3</b>
<b>INTRODUCTION</b> .....	<b>5</b>
<b>AVAILABLE OPTIONS</b> .....	<b>5</b>
<b>SPECIFICATIONS</b> .....	<b>6</b>
<b>EUROPEAN REGULATORY NOTES</b> .....	<b>7</b>
<b>EC DECLARATION OF CONFORMITY</b> .....	<b>7</b>
<b>DIRECTIVE 2002/95/EC (RoHS)</b> .....	<b>7</b>
<b>DIRECTIVE 2002/96/EC (WEEE)</b> .....	<b>7</b>
<b>INSTALLATION</b> .....	<b>9</b>
<b>VISUAL CHECK</b> .....	<b>9</b>
<b>POWER RATINGS</b> .....	<b>9</b>
<b>CONNECTION TO THE POWER SUPPLY</b> .....	<b>9</b>
<b>PROTECTION FROM ELECTRIC SHOCK</b> .....	<b>10</b>
<b>ENVIRONMENTAL CONDITIONS</b> .....	<b>10</b>
<b>FUSES</b> .....	<b>12</b>
<b>AC FUSE REPLACEMENT</b> .....	<b>12</b>
<b>DC FUSE REPLACEMENT</b> .....	<b>13</b>
<b>FUSE RATINGS</b> .....	<b>13</b>
<b>FRONT PANEL CONTROLS</b> .....	<b>14</b>
<b>REAR PANEL CONTROLS</b> .....	<b>16</b>
<b>GENERAL INFORMATION</b> .....	<b>17</b>
<b>BASIC TEST ARRANGEMENT</b> .....	<b>17</b>
<b>GENERAL OPERATING NOTES</b> .....	<b>17</b>
<b>MINIMIZING WAVEFORM DISTORTIONS</b> .....	<b>19</b>
<b>USE 50 OHM TRANSMISSION LINES AND LOADS</b> .....	<b>19</b>
<b>USE LOW-INDUCTANCE LOADS</b> .....	<b>19</b>
<b>PREVENTING DAMAGE</b> .....	<b>19</b>
<b>MECHANICAL INFORMATION</b> .....	<b>20</b>
<b>TOP COVER REMOVAL</b> .....	<b>20</b>
<b>ELECTROMAGNETIC INTERFERENCE</b> .....	<b>20</b>

- MAINTENANCE..... 21**
  - REGULAR MAINTENANCE..... 21
  - CLEANING..... 21
- WIRING DIAGRAMS..... 22**
  - WIRING OF AC POWER.....22
  - PCB 158K - LOW VOLTAGE POWER SUPPLY, 1/3.....23
  - PCB 158K - LOW VOLTAGE POWER SUPPLY, 2/3.....24
  - PCB 158K - LOW VOLTAGE POWER SUPPLY, 3/3.....25
  - MAIN WIRING..... 26
- PERFORMANCE CHECK SHEET..... 27**

Manual Reference: Z:\officefiles\instructword\avnn\avnn-1-c,edition2.odt.  
Last modified September 26, 2006.  
Copyright © 2006 Avtech Electrosystems Ltd, All Rights Reserved.

## INTRODUCTION

The AVNN series of pulse generators are high performance instruments capable of operating at pulse repetition frequencies from 25 MHz to 250 MHz, with 100 ps rise and fall times. The output duty cycle may vary from 30% to 70%.

Model AVNN-1-C generates amplitudes as high as 5 Volts (peak-to-peak).

The output is designed to drive 50 $\Omega$  loads. (A 50 $\Omega$  load is required for proper operation.) The output is AC-coupled.

This instrument is intended for use in research, development, test and calibration laboratories by qualified personnel.

## AVAILABLE OPTIONS

-OT Option: an internally generated DC offset, controlled by a front-panel dial, can be added to the output.

## SPECIFICATIONS

Model:	AVNN-1-C <sup>1</sup>
Amplitude: (50 Ohm load)	Variable to 5 Volts (peak to peak)
Pulse width:	Variable 1 to 30 ns
PRF:	25 MHz to 250 MHz
Rise time:	≤ 100 ps
Fall time:	≤ 100 ps
Duty cycle:	Variable, 30% to 70%
Polarity <sup>2</sup> :	0 to ± 2.5 Volts
Propagation delay:	≤ 5 ns (Ext trig in to pulse out)
Jitter:	± 15 ps (Ext trig in to pulse out)
DC offset or bias insertion <sup>3</sup> :	Apply required DC offset to back-panel solder terminals (± 50 Volts, 250 mA max)
Trigger required:	Ext trig mode: 0.3 V <sub>RMS</sub> sine wave or 50% duty cycle square wave
Sync output:	50 mV square wave
Monitor output:	Provides a 20 dB attenuated coincident replica of main output
Connectors:	Out: SMA, Trig: BNC, Sync: BNC, Monitor: SMA
Power:	100 - 240 Volts, 50 - 60 Hz
Dimensions:	100 mm x 430 mm x 375 mm (3.9" x 17" x 14.8")

1. -C suffix indicates stand-alone lab instrument with internal clock and line powering.
2. The high duty cycle waveform is AC-coupled and so the output is bipolar. A unipolar output may be obtained by inserting a DC offset.
3. For internally generated DC offset (0 to ±5 V, one-turn control) add suffix -OT to model number. -OT and -EO options are not available on modules.

## EUROPEAN REGULATORY NOTES

### EC DECLARATION OF CONFORMITY

We Avtech Electrosystems Ltd.  
P.O. Box 5120, LCD Merivale  
Ottawa, Ontario  
Canada K2C 3H4

declare that this pulse generator meets the intent of Directive 89/336/EEC for Electromagnetic Compatibility. Compliance pertains to the following specifications as listed in the official Journal of the European Communities:

EN 50081-1 Emission

EN 50082-1 Immunity

and that this pulse generator meets the intent of the Low Voltage Directive 72/23/EEC as amended by 93/68/EEC. Compliance pertains to the following specifications as listed in the official Journal of the European Communities:

EN 61010-1:2001 Safety requirements for electrical equipment for measurement, control, and laboratory use



### DIRECTIVE 2002/95/EC (RoHS)

This instrument is exempt from Directive 2002/95/EC of the European Parliament and of the Council of 27 January 2003 on the Restriction of the use of certain Hazardous Substances (RoHS) in electrical and electronic equipment. Specifically, Avtech instruments are considered "Monitoring and control instruments" (Category 9) as defined in Annex 1A of Directive 2002/96/EC. The Directive 2002/95/EC only applies to Directive 2002/96/EC categories 1-7 and 10, as stated in the "Article 2 - Scope" section of Directive 2002/95/EC.

### DIRECTIVE 2002/96/EC (WEEE)

European customers who have purchased this equipment directly from Avtech will have completed a "WEEE Responsibility Agreement" form, accepting responsibility for

WEEE compliance (as mandated in Directive 2002/96/EC of the European Union and local laws) on behalf of the customer, as provided for under Article 9 of Directive 2002/96/EC.

Customers who have purchased Avtech equipment through local representatives should consult with the representative to determine who has responsibility for WEEE compliance. Normally, such responsibilities will lie with the representative, unless other arrangements (under Article 9) have been made.

Requirements for WEEE compliance may include registration of products with local governments, reporting of recycling activities to local governments, and financing of recycling activities.

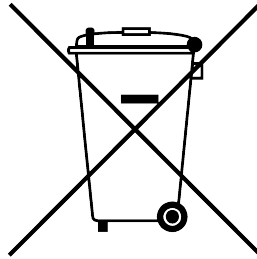



## INSTALLATION

### VISUAL CHECK

After unpacking the instrument mainframe and the transformer module, examine to ensure that they have not been damaged in shipment. Visually inspect all connectors, knobs, and handles. Confirm that a power cord and an instrumentation manual (this manual), are with the instrument. If the instrument has been damaged, file a claim immediately with the company that transported the instrument.

### POWER RATINGS

This instrument is intended to operate from 100 - 240 V, 50 - 60 Hz.

The maximum power consumption is 57 Watts. Please see the "FUSES" section for information about the appropriate AC and DC fuses.

This instrument is an "Installation Category II" instrument, intended for operation from a normal single-phase supply.

### CONNECTION TO THE POWER SUPPLY

An IEC-320 three-pronged recessed male socket is provided on the back panel for AC power connection to the instrument. One end of the detachable power cord that is supplied with the instrument plugs into this socket. The other end of the detachable power cord plugs into the local mains supply. Use only the cable supplied with the instrument. The mains supply must be earthed, and the cord used to connect the instrument to the mains supply must provide an earth connection. (The supplied cord does this.)

 Warning: Failure to use a grounded outlet may result in injury or death due to electric shock. This product uses a power cord with a ground connection. It must be connected to a properly grounded outlet. The instrument chassis is connected to the ground wire in the power cord.

The table below describes the power cord that is normally supplied with this instrument, depending on the destination region:

Destination Region	Description	Manufacturer	Part Number
Continental Europe	European CEE 7/7 "Schuko" 230V, 50Hz	Volex ( <a href="http://www.volex.com">http://www.volex.com</a> )	17850-C3-326
		Qualtek ( <a href="http://www.qualtekusa.com">http://www.qualtekusa.com</a> )	319004-T01
United Kingdom	BS 1363, 230V, 50Hz	Qualtek ( <a href="http://www.qualtekusa.com">http://www.qualtekusa.com</a> )	370001-E01
Switzerland	SEV 1011, 2 30V, 50Hz	Volex ( <a href="http://www.volex.com">http://www.volex.com</a> )	2102H-C3-10
Israel	SI 32, 220V, 50Hz	Volex ( <a href="http://www.volex.com">http://www.volex.com</a> )	2115H-C3-10
North America, and all other areas	NEMA 5-15, 120V, 60 Hz	Qualtek ( <a href="http://www.qualtekusa.com">http://www.qualtekusa.com</a> )	312007-01

## PROTECTION FROM ELECTRIC SHOCK

 Operators of this instrument must be protected from electric shock at all times. The owner must ensure that operators are prevented access and/or are insulated from every connection point. In some cases, connections must be exposed to potential human contact. Operators must be trained to protect themselves from the risk of electric shock. This instrument is intended for use by qualified personnel who recognize shock hazards and are familiar with safety precautions required to avoid possibly injury. In particular, operators should:

1. Keep exposed high-voltage wiring to an absolute minimum.
2. Wherever possible, use shielded connectors and cabling.
3. Connect and disconnect loads and cables only when the instrument is turned off.
4. Keep in mind that all cables, connectors, oscilloscope probes, and loads must have an appropriate voltage rating.
5. Do not attempt any repairs on the instrument, beyond the fuse replacement procedures described in this manual. Contact Avtech technical support (see page 2 for contact information) if the instrument requires servicing. Service is to be performed solely by qualified service personnel.

## ENVIRONMENTAL CONDITIONS

This instrument is intended for use under the following conditions:

1. indoor use;
2. altitude up to 2 000 m;
3. temperature 5 °C to 40 °C;

4. maximum relative humidity 80 % for temperatures up to 31 °C decreasing linearly to 50 % relative humidity at 40 °C;
5. Mains supply voltage fluctuations up to  $\pm 10$  % of the nominal voltage;
6. no pollution or only dry, non-conductive pollution.

## FUSES

This instrument contains four fuses. All are accessible from the rear-panel. Two protect the AC prime power input, and two protect the internal DC power supplies. The locations of the fuses on the rear panel are shown in the figure below:

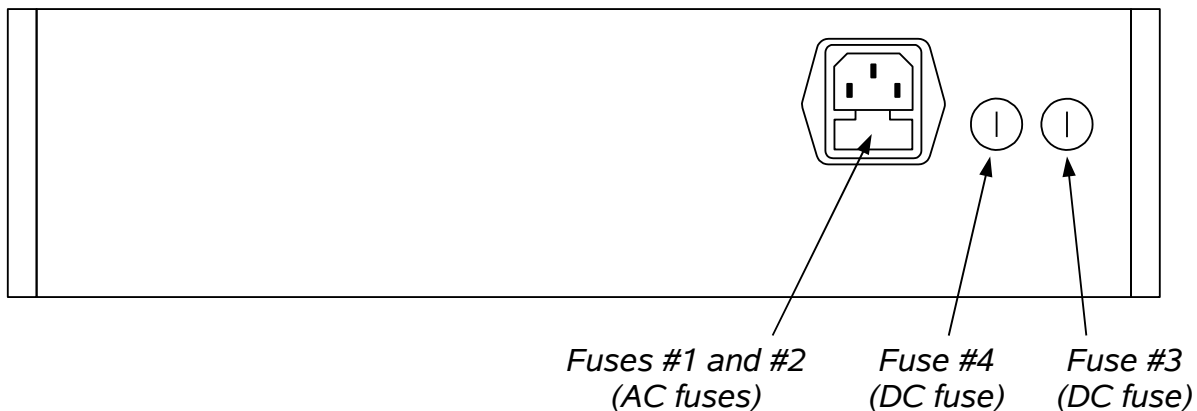

### AC FUSE REPLACEMENT

To physically access the AC fuses, the power cord must be detached from the rear panel of the instrument. The fuse drawer may then be extracted using a small flat-head screwdriver, as shown below:

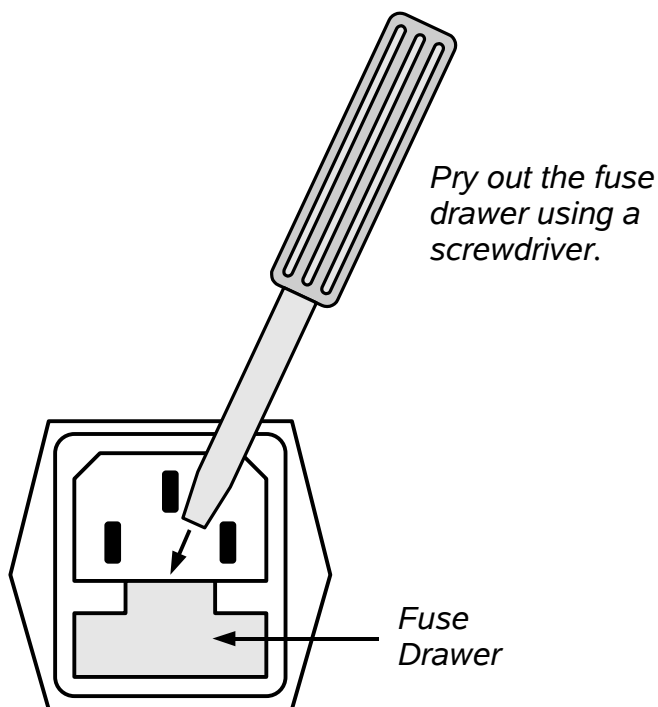

## DC FUSE REPLACEMENT

The DC fuses may be replaced by inserting the tip of a flat-head screwdriver into the fuse holder slot, and rotating the slot counter-clockwise. The fuse and its carrier will then pop out.

## FUSE RATINGS

The following table lists the required fuses:

Fuses	Nominal Mains Voltage	Rating	Case Size	Recommended Replacement Part	
				Littelfuse Part Number	Digi-Key Stock Number
#1, #2 (AC)	100-240V	0.5A, 250V, Time-Delay	5×20 mm	0218.500HXP	F2416-ND
#3 (DC)	N/A	1.6A, 250V, Time-Delay	5×20 mm	021801.6HXP	F2424-ND
#4 (DC)	N/A	0.5A, 250V, Time-Delay	5×20 mm	0218.500HXP	F2416-ND

The recommended fuse manufacturer is Littelfuse (<http://www.littelfuse.com>).

Replacement fuses may be easily obtained from Digi-Key (<http://www.digikey.com>) and other distributors.

## FRONT PANEL CONTROLS

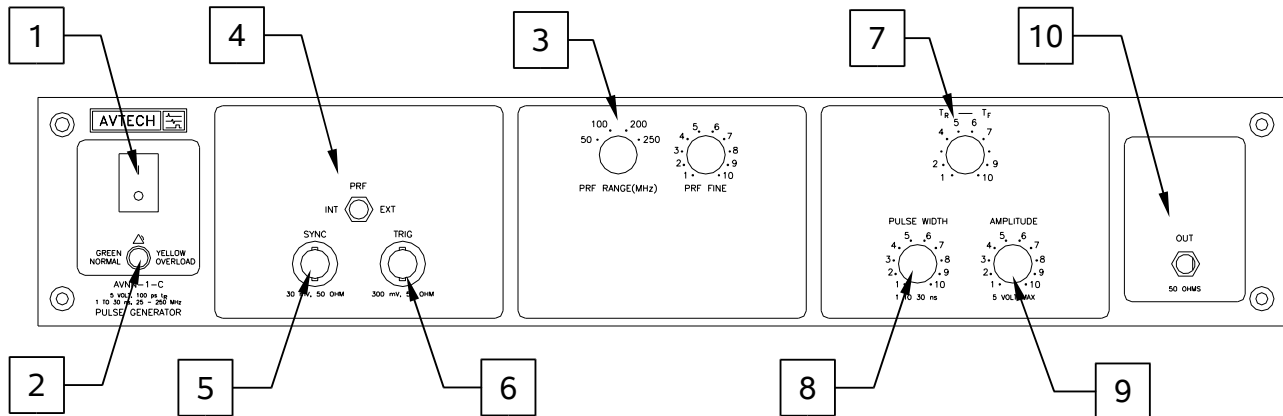

1. **POWER Switch**. This is the main power switch. When turning the instrument on, there may be a delay of several seconds before the instrument appears to respond.
2. **OVERLOAD Indicator**. When the instrument is powered, this indicator is normally green, indicating normal operation. If this indicator is yellow, an internal automatic overload protection circuit has been tripped. If the unit is overloaded (by operating at an exceedingly high duty cycle or by operating into a very low impedance), the protective circuit will disable the output of the instrument and turn the indicator light yellow. The light will stay yellow (i.e. output disabled) for about 5 seconds after which the instrument will attempt to re-enable the output (i.e. light green) for about 1 second. If the overload condition persists, the output will be disabled again (i.e. light yellow) for another 5 seconds. If the overload condition has been removed, the instrument will resume normal operation.

This overload indicator may flash yellow briefly at start-up. This is not a cause for concern.

Note that the output stage will safely withstand a short-circuited load condition.

3. **PRF Range Switch**. This switch sets the pulse repetition frequency (PRF) range of the internal oscillator. The marked value of each position is the upper limit of the range, approximately. The vernier dial directly to the right of the switch varies the PRF within the set range.
4. **INT / EXT Switch**. When this switch is in the INT position, the instrument is triggered by the internal oscillator, whose repetition frequency is controlled by item (3). When this switch is in the EXT position, the instrument requires a 0.3 V RMS sine wave applied at the TRIG input in order to trigger the output stages. In this mode the oscilloscope time base must be triggered by the external trigger source.

5. SYNC Output. This output is approximately coincident with the main output and may be used to trigger a sampling scope time base. The output is a 50 mV sine wave capable of driving a 50 Ohm load.
6. TRIG Input. The external trigger signal is applied at this input when the EXT-INT toggle switch is in the EXT position. See item (4).
7. TR-TF Controls. This dial controls flatness of pulse top and rise and fall time. Turn counter-clockwise to smooth top and to decrease rise, fall time.
8. PW Control. This dial varies the output pulse width / duty cycle. The duty cycle may be adjusted from approximately 30% to 70%.
9. AMP Control. This dial varies the output pulse amplitude from zero to maximum output.
10. OUT Connector. This SMA connector provides the main output to a 50 Ohm load.

## REAR PANEL CONTROLS

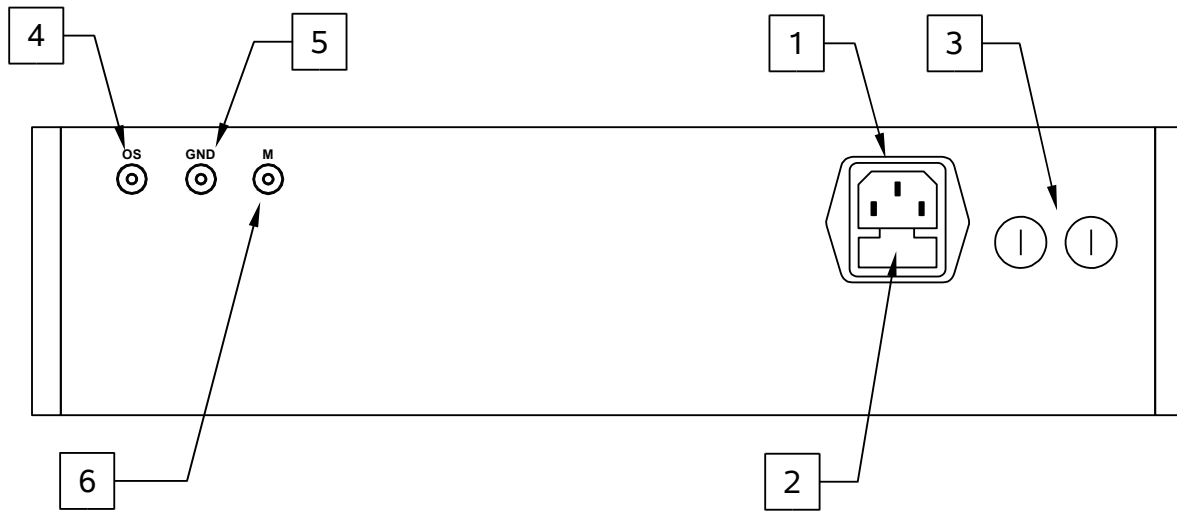

1. AC POWER INPUT. An IEC-320 C14 three-pronged recessed male socket is provided on the back panel for AC power connection to the instrument. One end of the detachable power cord that is supplied with the instrument plugs into this socket.
2. AC FUSE DRAWER. The two fuses that protect the AC input are located in this drawer. Please see the “FUSES” section of this manual for more information.
3. DC FUSES. These two fuses protect the internal DC power supplies. Please see the “FUSES” sections of this manual for more information.
4. OS INPUT CONNECTOR. A DC offset in the range of  $\pm 50\text{V}$  (250 mA max) may be applied to this solder terminal. The DC offset will appear on the output. When this feature is not used, the OS input should be connected to ground (using the adjacent GND connector). This is especially important when driving loads containing a diode.
5. GND CONNECTOR. This solder terminal is connected to ground. It may be used to ground the OS input connector.
6. M OUTPUT CONNECTOR. This SMA connector output provides a 20 dB attenuated coincident replica of main output, for monitoring purposes.



## GENERAL INFORMATION

### BASIC TEST ARRANGEMENT

The AVNN-1-C should be tested with a sampling oscilloscope with a bandwidth of at least 10 GHz to properly observe the high-speed waveform. A typical test arrangement is shown below:

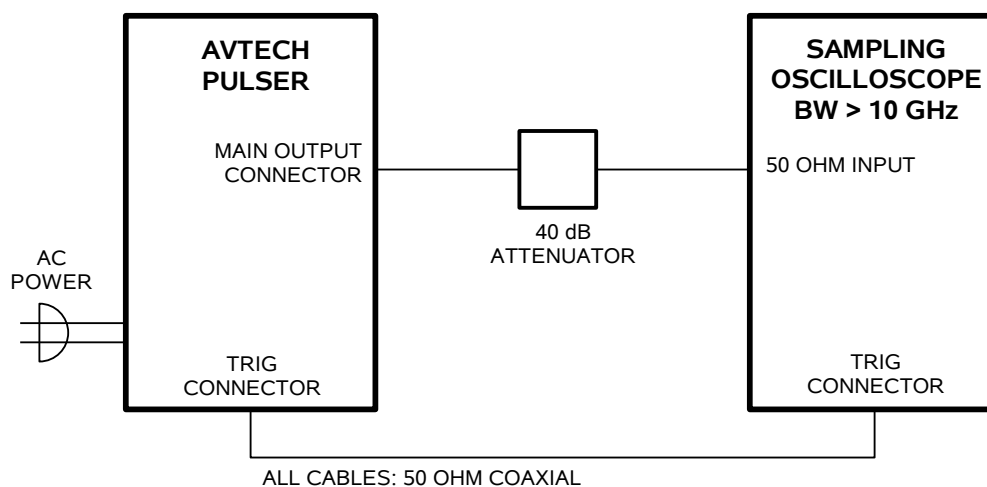

The attenuator is required to prevent damage to the sampling oscilloscope.

### GENERAL OPERATING NOTES

- 1) The bandwidth capability of components and instruments used to display the pulse generator output signal (attenuators, cables, connectors, etc.) should exceed 10 GHz.
- 2) The use of 40 dB attenuator at the sampling scope vertical input channel will insure a peak input signal to the sampling scope of less than 1 Volt.
- 3) The SYNC output provides a 50 mV sine wave (to 50 Ohms).
- 4) To obtain a stable output display on a sampling oscilloscope, the PRF RANGE and PRF controls, TR-TF controls, and amplitude controls on the front panel should initially all be set mid-range. The front panel INT/EXT switch should be in the INT position. The prime power should be turned on and the scope triggering controls adjusted to obtain a stable display. The PRF range switch and PRF control may then be adjusted to obtain the desired output PRF.
- 5) Clockwise rotation of the PW control increases the output duty cycle. Adjust for desired output pulse width (30 to 70% duty cycle).

- 6) The desired output amplitude is controlled primarily by the AMP control and partially by the TR-TF control. The TR-TF control also serves to sharpen the rise and fall times and to flatten the pulse top. Several iterative adjustments of the AMP and TR-TF controls may be necessary to simultaneously obtain the desired output amplitude while maintaining excellent pulse rise-fall times and flatness.
- 7) To trigger externally, set the INT-EXT switch to EXT and connect a sine wave generator to the TRIG connector. The output PRF will equal the sine wave PRF. The sine wave amplitude should be set at 0.3 VRMS.
- 8) To add a DC offset to the output pulse, connect a DC power supply set to required DC offset value to the back panel terminals marked "OS". The maximum attainable DC offset voltage is  $\pm 50$  Volts (for units without the -OT option only).

## MINIMIZING WAVEFORM DISTORTIONS

### USE 50 OHM TRANSMISSION LINES AND LOADS

Connect the load to the pulse generator with 50 $\Omega$  transmission lines (e.g. RG-58, RG-174, or RG-316 cable).

This instrument requires a 50 $\Omega$  load for proper operation. It will not properly drive a high-impedance load. The output stage will be damaged if it is operated into an open circuit (or any other high impedance). Failures due to improper output loading are not covered by the warranty.

### USE LOW-INDUCTANCE LOADS

Lenz's Law predicts that for an inductive voltage spike will be generated when the current through an inductance changes. Specifically,  $V_{\text{SPIKE}} = L \times di_{\text{LOAD}}/dt$ , where L is the inductance,  $i_{\text{LOAD}}$  is the load current change, and t is time. For this reason, it is important to keep any parasitic in the load low. This means keeping wiring short, and using low inductance components. In particular, wire-wound resistors should be avoided.

## PREVENTING DAMAGE

The AVNN-1-C may fail if triggered at a PRF greater than 250 MHz.

This unit is designed to operate into a load impedance of 50 Ohms and the output stage will be damaged if it is operated into an open circuit (or any other high impedance). Failures due to improper output loading are not covered by the warranty.

The lifetime of the switching elements in the pulse generator module is proportional to the running time of the instrument. For this reason the prime power to the instrument should be turned off when the instrument is not in use.

## MECHANICAL INFORMATION

### TOP COVER REMOVAL

If necessary, the interior of the instrument may be accessed by removing the four Phillips screws on the top panel. With the four screws removed, the top cover may be slid back (and off).

 Always disconnect the power cord and allow the instrument to sit unpowered for 10 minutes before opening the instrument. This will allow any internal stored charge to discharge.

There are no user-adjustable internal circuits. For repairs other than fuse replacement, please contact Avtech ([info@avtechpulse.com](mailto:info@avtechpulse.com)) to arrange for the instrument to be returned to the factory for repair. Service is to be performed solely by qualified service personnel.

 Caution: High voltages are present inside the instrument during normal operation. Do not operate the instrument with the cover removed.

### ELECTROMAGNETIC INTERFERENCE

To prevent electromagnetic interference with other equipment, all used outputs should be connected to shielded loads using shielded coaxial cables. Unused outputs should be terminated with shielded coaxial terminators or with shielded coaxial dust caps, to prevent unintentional electromagnetic radiation. All cords and cables should be less than 3m in length.

## MAINTENANCE

### REGULAR MAINTENANCE

This instrument does not require any regular maintenance.

On occasion, one or more of the four rear-panel fuses may require replacement. All fuses can be accessed from the rear panel. See the “FUSES” section for details.

### CLEANING

If desired, the interior of the instrument may be cleaned using compressed air to dislodge any accumulated dust. (See the “TOP COVER REMOVAL” section for instructions on accessing the interior.) No other cleaning is recommended.

# WIRING DIAGRAMS

## WIRING OF AC POWER

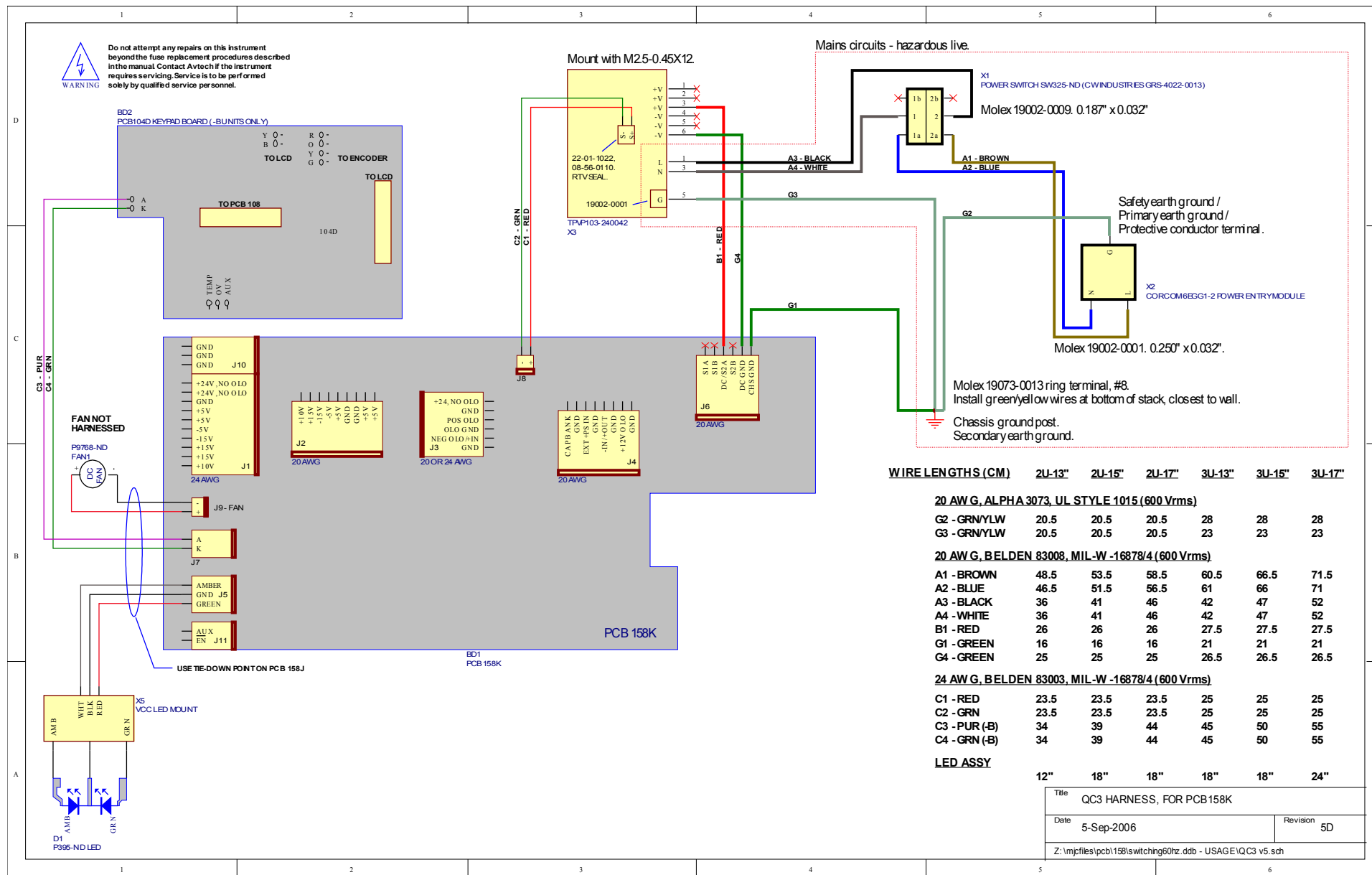

# PCB 158K - LOW VOLTAGE POWER SUPPLY, 1/3

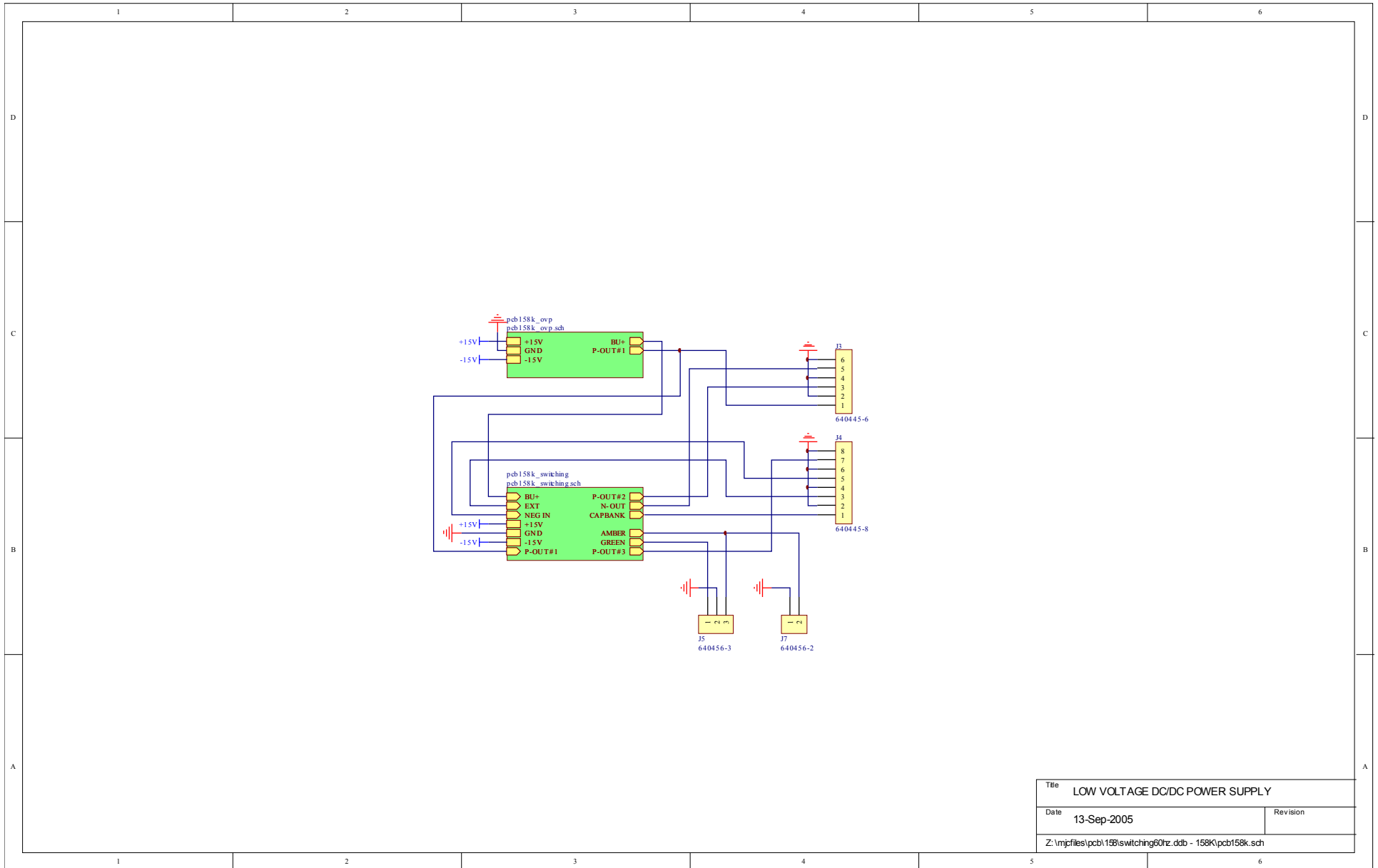

Title		LOW VOLTAGE DC/DC POWER SUPPLY
Date	13-Sep-2005	Revision
Z:\mpjfiles\pcb158\switching60hz.ddb - 158K\pcb158k.sch		

# PCB 158K - LOW VOLTAGE POWER SUPPLY, 2/3

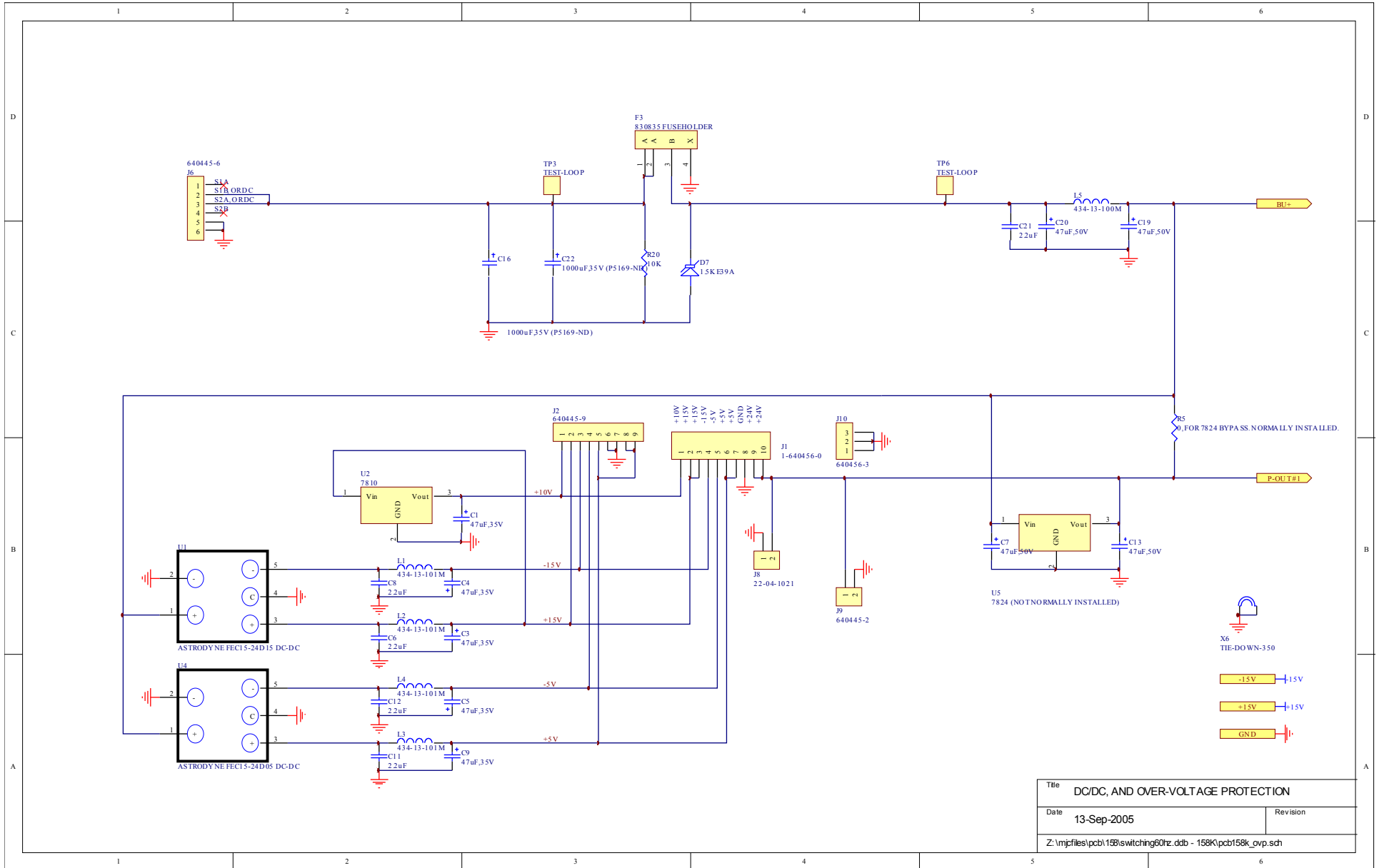



# PCB 158K - LOW VOLTAGE POWER SUPPLY, 3/3

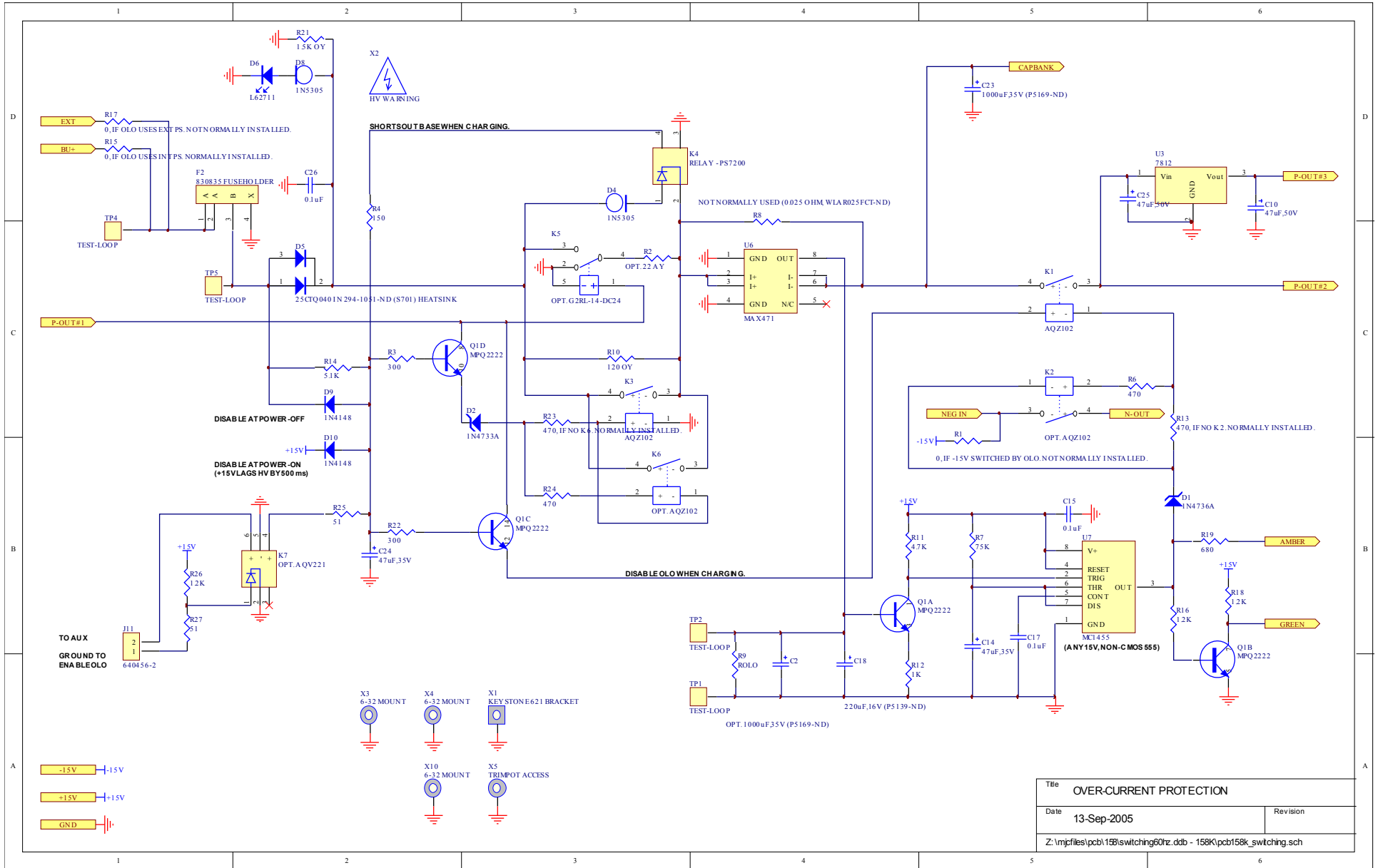

# MAIN WIRING

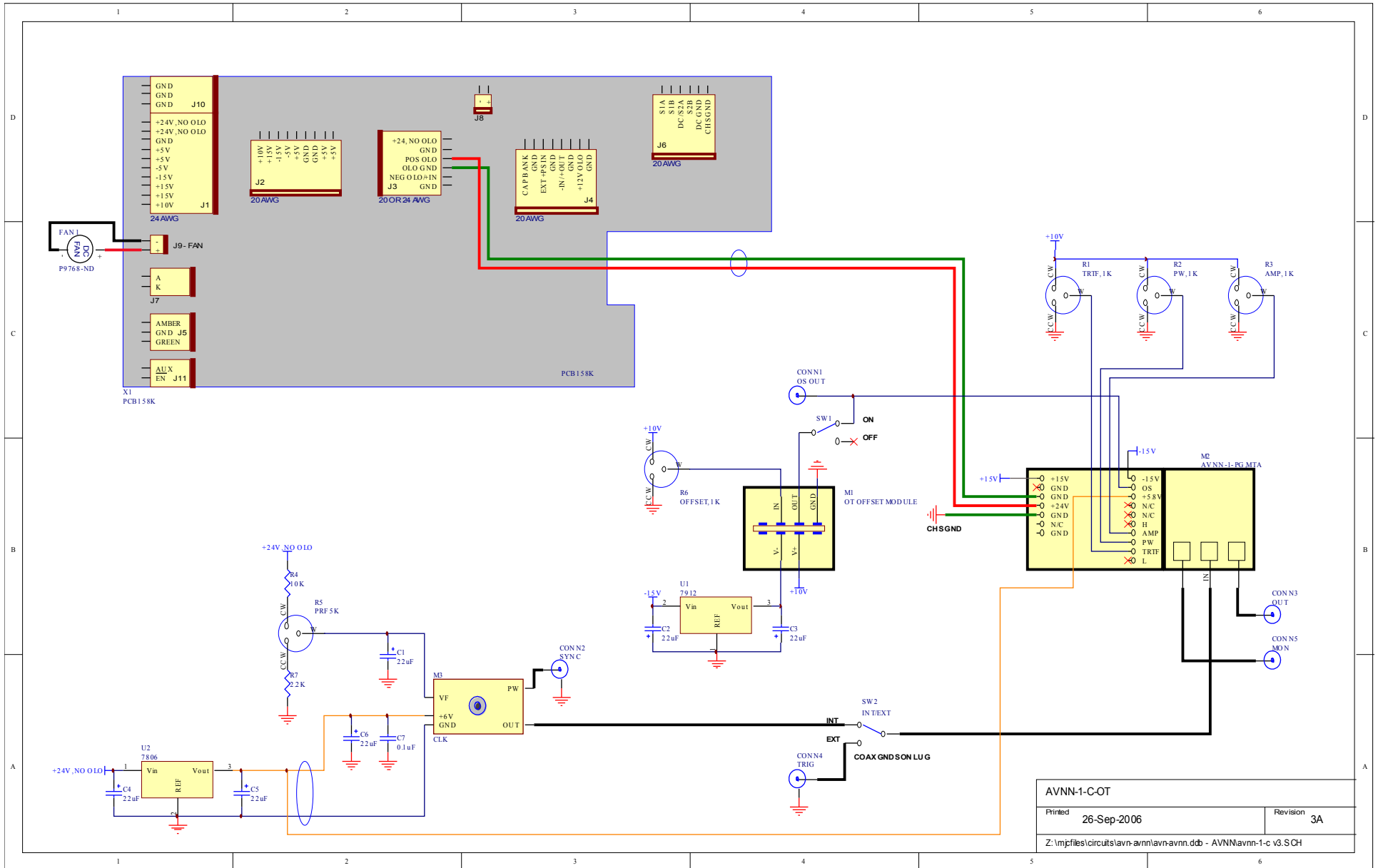

AVNN-1-C-OT		
Printed	26-Sep-2006	Revision 3A
Z:\mpfiles\circuits\avn-avn\avn-avn.ddb - AVNN\avn-1-c v3.SCH		

PERFORMANCE CHECK SHEET